

The background of the top section features a grayscale image of industrial machinery, including a large gear-like component and various pipes and mechanical parts.

HARE & FORBES

MACHINERYHOUSE

Established 1930

Distributors of New & Used Workshop Equipment

ELECTRIC / MECHANICAL PIPE / TUBE BENDERS

WARNING

General Machinery Safety Instructions

Machinery House
requires you to read this entire Manual before using this machine.

- 1. Read the entire Manual before starting machinery.** Machinery may cause serious injury if not correctly used.
- 2. Always use correct hearing protection when operating machinery.** Machinery noise may cause permanent hearing damage.
- 3. Machinery must never be used when tired, or under the influence of drugs or alcohol.** When running machinery you must be alert at all times.
- 4. Wear correct Clothing.** At all times remove all loose clothing, necklaces, rings, jewelry, etc. Long hair must be contained in a hair net. Non-slip protective footwear must be worn.
- 5. Always wear correct respirators around fumes or dust when operating machinery.** Machinery fumes & dust can cause serious respiratory illness. Dust extractors must be used where applicable.
- 6. Always wear correct safety glasses.** When machining you must use the correct eye protection to prevent injuring your eyes.
- 7. Keep work clean and make sure you have good lighting.** Cluttered and dark shadows may cause accidents.
- 8. Personnel must be properly trained or well supervised when operating machinery.** Make sure you have clear and safe understanding of the machine you are operating.
- 9. Keep children and visitors away.** Make sure children and visitors are at a safe distance for you work area.
- 10. Keep your workshop childproof.** Use padlocks, Turn off master power switches and remove start switch keys.
- 11. Never leave machine unattended.** Turn power off and wait till machine has come to a complete stop before leaving the machine unattended.
- 12. Make a safe working environment.** Do not use machine in a damp, wet area, or where flammable or noxious fumes may exist.
- 13. Disconnect main power before service machine.** Make sure power switch is in the off position before re-connecting.
- 14. Use correct amperage extension cords.** Undersized extension cords overheat and lose power. Replace extension cords if they become damaged.
- 15. Keep machine well maintained.** Keep blades sharp and clean for best and safest performance. Follow instructions when lubricating and changing accessories.
- 16. Keep machine well guarded.** Make sure guards on machine are in place and are all working correctly.
- 17. Do not overreach.** Keep proper footing and balance at all times.
- 18. Secure workpiece.** Use clamps or a vice to hold the workpiece where practical. Keeping the workpiece secure will free up your hand to operate the machine and will protect hand from injury.
- 19. Check machine over before operating.** Check machine for damaged parts, loose bolts, Keys and wrenches left on machine and any other conditions that may effect the machines operation. Repair and replace damaged parts.
- 20. Use recommended accessories.** Refer to instruction manual or ask correct service officer when using accessories. The use of improper accessories may cause the risk of injury.
- 21. Do not force machinery.** Work at the speed and capacity at which the machine or accessory was designed.
- 22. Use correct lifting practice.** Always use the correct lifting methods when using machinery. Incorrect lifting methods can cause serious injury.
- 23. Lock mobile bases.** Make sure any mobile bases are locked before using machine.
- 24. Allergic reactions.** Certain metal shavings and cutting fluids may cause an allergic reaction in people and animals, especially when cutting as the fumes can be inhaled. Make sure you know what type of metal and cutting fluid you will be exposed to and how to avoid contamination.
- 25. Call for help.** If at any time you experience difficulties, stop the machine and call you nearest branch service department for help.

WARNING

Elec/Mech Pipe/Tube Bender Safety Instructions

Machinery House
requires you to read this entire Manual before using this machine.

- 1. Maintenance.** Make sure the Pipe/Tube Bender is turned off and disconnect from the main power supply and make sure all moving parts have come to a complete stop before any inspection, adjustment or maintenance is carried out.
- 2. Pipe Bender Condition.** Pipe/Tube Bender must be maintained for a proper working condition. Never operate a Pipe/Tube Bender that has damaged or worn parts. Scheduled routine maintenance should be performed on a scheduled basis. Check frame, rollers, springs & formers for cracks or damage. Replace if necessary.
- 3. Former Condition.** Never operate a Pipe/Tube Bender with damaged or badly worn Formers. Replace if required.
- 4. Hand Hazard.** Keep hands away from the Pipe/Tube Bender, under any circumstances, while the machine is in operation mode. Serious injury can occur.
- 5. Gloves & Glasses.** Always wear leather gloves and approved safety glasses when using this machine.
- 6. Work area hazards.** Keep the area around the Pipe/Tube Bender clean from oil, tools, objects & chips. Pay attention to other persons in the area and know what is going on around the area to ensure unintended accidents.
- 7. Guards.** Do not operate Pipe/Tube Bender without the correct guards in place. Necessary guards protect you from injuries by worm-type gearbox and other gears. The only other area which needs to be carefully monitored during use is the rotational area of the formers.
- 8. Understand the machines controls.** Make sure you understand the use and operation of all controls.
- 9. Overloading Pipe/Tube Bender.** Do not overload the machine by using material which exceeds the rated capacity.
- 10. Avoiding Entanglement.** Pipe/Tube Bender guards must be used at all times. Tie up long hair and use the correct hair nets to avoid any entanglement with the Pipe/Tube Benders moving parts.
- 11. Trained Operator.** This machine must be operated by authorized and trained personnel.
- 12. Power outage.** In the event of a power failure during use of the machine, turn off all switches to avoid possible sudden start up once power is restored.
- 13. Warning Labels.** Take note of any warning labels on the machine and do not remove them.
- 14. Material Hazard.** Do not bend plastics or other objects that could shatter. Serious injury can occur.
- 15. Stopping the Former.** Do not stop or slow the former with your hand or workpiece. Allow the machine to stop on its own.
- 16. Secure Pipe/Tube Bender.** Make sure you bolt the machine down so it is secure when in operation.
- 17. Pinching.** Prevent pinching by releasing pressure on the workpiece when not in use.
- 18. Emergency stop.** Use the emergency stop button in case of any emergency.
- 19. Hearing protection and hazards.** Always wear hearing protection as noise generated from machine and workpiece can cause permanent hearing loss over time.
- 20. Call for help.** If at any time you experience difficulties, stop the machine and call your nearest branch service department for help.

PLANT SAFETY PROGRAM
NEW MACHINERY HAZARD IDENTIFICATION, ASSESSMENT & CONTROL

Electric/Mechanical Pipe/Tube Benders

Developed in Co-operation Between A W/1 S, A and Australia Chamber of Manufactures
 This program is based upon the Safe Work Australia, Code of Practice - Managing Risks of Plant in the Workplace (WHSA 2011 No10)

Item No.	Hazard Identification	Hazard Assessment	Risk Control Strategies <small>(Recommended for Purchase / Buyer / User)</small>
B	CRUSHING	HIGH	Do not exceed maximum capacity. Check equipment for damage prior to use. Wear safety boots. Never put any part of your body between moving formers and material. Always support material properly.
C	CUTTING, STABBING OR PUNCTURING STRIKING	MEDIUM	Use equipment in the correct manner as to avoid parts being ejected out under pressure.
E		MEDIUM	Use equipment in the correct manner as to avoid parts being ejected out under pressure. Ensure correct formers are used for the correct job.
H	ELECTRICAL	MEDIUM	All electrical enclosures should only be opened with a tool that is not to be kept with the machine. Machine should be installed & checked by a Licensed Electrician.
O	OTHER HAZARDS, NOISE.	LOW	Wear hearing protection as required.
Plant Safety Program to be read in conjunction with manufactures instructions			



www.machineryhouse.com.au



www.machineryhouse.co.nz

Authorised and signed by:
 Safety officer:

Manager:

Revised Date: 12th March 2012

BENDING MACHINE

INSTRUCTION MANUAL

ORIGINAL INSTRUCTIONS

For your personal safety,

READ and UNDERSTAND before using.

SAVE THESE INSTRUCTIONS FOR FUTURE REFERENCE.



CE CB 

FUNCTIONAL DESCRIPTION

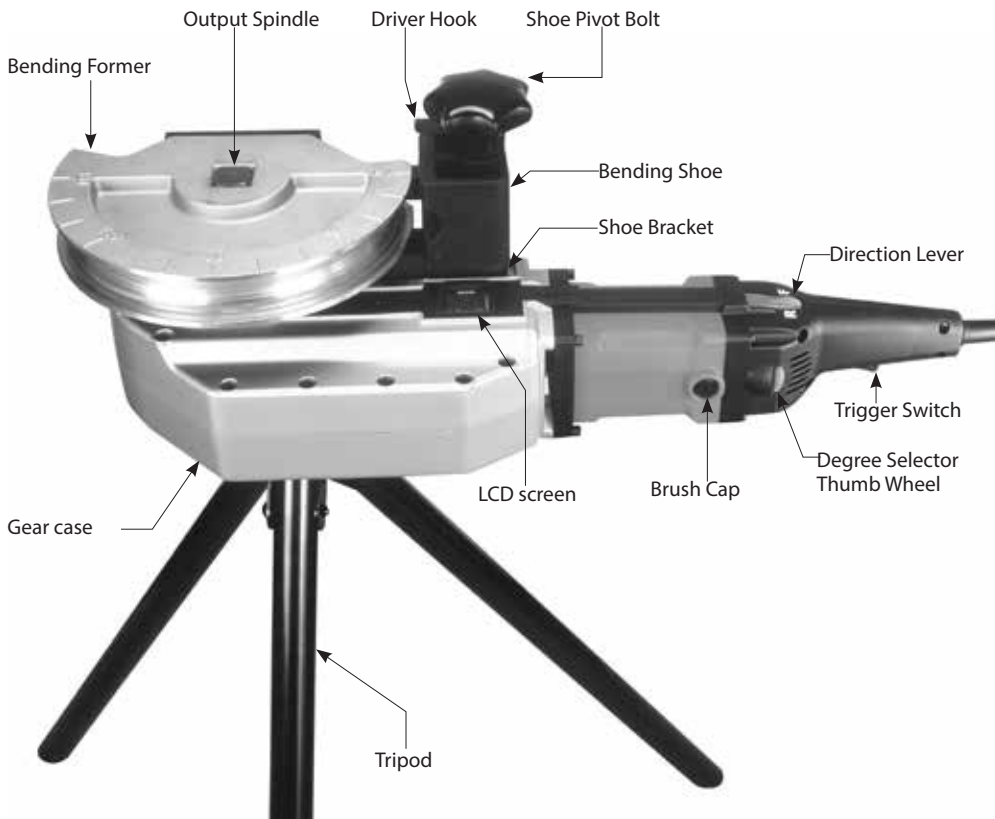

Bending Former & Bending Shoe



1. 5/8" R=4D
2. 3/4" R=4D
3. 7/8" R=4D
4. 1" R=4D
5. 1-1/8" R=4D
6. 1-1/4" R=4D

Voltage	See machine nameplate
Power Input	1700W
No Load min ⁻¹	3.5
Max. Capacity	Φ32mm (1-1/4")
Insulation	Double Insulation (Class II)
Net Weight	14kg (30.8 Lbs)

GENERAL SAFETY INSTRUCTIONS



WARNING! Read all safety warnings and all instructions. Failure to follow the warnings and instructions may result in electric shock, fire and/or serious injury.

Save all warnings and instructions for future reference. The term “power tool” in the warnings refers to your mainsoperated (corded) power tool or battery-operated (cordless) power tool.

1) WORK AREA SAFETY

- a. **Keep work area clean and well lit.** Cluttered or dark areas invite accidents.
- b. **Do not operate power tools in explosive atmospheres, such as in the presence of flammable liquids, gases or dust.** Power tools create sparks which may ignite the dust or fumes.
- c. **Keep children and bystanders away while operating a power tool.** Distractions can cause you to lose control.

2) ELECTRICAL SAFETY

- a. **Power tool plugs must match the outlet. Never modify the plug in any way. Do not use any adapter plugs with earthed (grounded) power tools.**
Unmodified plugs and matching outlets will reduce risk of electric shock.
- b. **Avoid body contact with earthed or grounded surfaces such as pipes, radiators, ranges and refrigerators.** There is an increased risk of electric shock if your body is earthed or grounded.
- c. **Do not expose power tools to rain or wet conditions.** Water entering a power tool will increase the risk of electric shock.
- d. **Do not abuse the cord. Never use the cord for carrying, pulling or unplugging the power tool. Keep cord away from heat, oil,**

sharp edges or moving parts. Damaged or entangled cords increase the risk of electric shock.

- e. **When operating a power tool outdoors, use an extension cord suitable for outdoor use.** Use of a cord suitable for outdoor use reduces the risk of electric shock.
- f. **If operating a power tool in a damp location is unavoidable, use an earth leakage circuit breaker.** Use of an earth leakage circuit breaker reduces the risk of electric shock.

3) PERSONAL SAFETY

- a. **a) Stay alert, watch what you are doing and use common sense when operating a power tool. Do not use a power tool while you are tired or under the influence of drugs, alcohol or medication.** A moment of inattention while operating power tools may result in serious personal injury.
- b. **b) Use personal protective equipment. Always wear eye protection.** Protective equipment such as dust mask, non-skid safety shoes, hard hat, or hearing protection used for appropriate conditions will reduce personal injuries.
- c. **Prevent unintentional starting. Ensure the switch is in the off-position before connecting to power source and/or battery pack, picking up or carrying the tool.** Carrying power tools with your finger on the switch or energising power tools that have the switch on invites accidents.
- d. **Remove any adjusting key or wrench before turning the power tool on.** A wrench or a key left attached to a rotating part of the power tool may result in personal injury.
- e. **Do not overreach. Keep proper footing and balance at all times.** This enables better control of the power tool in unexpected situations.
- f. **Dress properly. Do not wear loose clothing**

or jewelry. Keep your hair, clothing and gloves away from moving parts. Loose clothes, jewelry or long hair can be caught in moving parts.

g. If devices are provided for the connection of dust extraction and collection facilities, ensure these are connected and properly used. Use of dust collection can reduce dust-related hazards.

4) POWER TOOL USE AND CARE

a. Do not force the power tool. Use the correct power tool for your application. The correct power tool will do the job better and safer at the rate for which it was designed.

b. Do not use the power tool if the switch does not turn it on and off. Any power tool that cannot be controlled with the switch is dangerous and must be repaired.

c. Disconnect the plug from the power source and/or the battery pack from the power tool before making any adjustments, changing accessories, or storing power tools. Such preventive safety measures reduce the risk of starting the power tool accidentally.

d. Store idle power tools out of the reach of children and do not allow persons unfamiliar with the power tool or these instructions to operate the power tool. Power tools are dangerous in the hands of untrained users.

e. Maintain power tools. Check for misalignment or binding of moving parts, breakage of parts and any other condition that may affect the power tool's operation. If damaged, have the power tool repaired before use. Many accidents are caused by poorly maintained power tools.

f. Keep cutting tools sharp and clean. Properly maintained cutting tools with sharp cutting edges are less likely to bind and are easier to control.

g. Use the power tool, accessories and tool bits etc., in accordance with these instructions, taking into account the working conditions and the work to be performed. Use of the power tool for

operations different from those intended could result in a hazardous situation.

5) SERVICE

Have your power tool serviced by a qualified repair person using only identical replacement parts. This will ensure that the safety of the power tool is maintained.

Symbols used in this manual

- V.....volts
- A.....amperes
- Hz.....hertz
- W.....watt
- ~.....alternating current
- n_0no load speed
- min^{-1}revolutions or reciprocation per minute

warning of general danger

class II tool

with electrical earth

read these instructions

always wear eye protection

always wear a dust mask.

always wear hearing protection

wear safety-approved hard hat

Keep hands clear – pinching hazard.

 rotating parts - entanglement hazard. Keep hands, loose clothing and long hair away from moving parts

 do not dispose of electric tools, accessories and packaging together with household waste material

SPECIFIC SAFETY RULES

1. **Keep the working area clear for the bending process.** Obstructions could cause a hazard and interfere with the bending process.
2. **Do not exceed the maximum pipe diameter and wall thickness specified for this machine.** Use of over-capacity sizes will cause a safety hazard and could damage the machine.
3. **Keep the hands away from all moving parts during the bending process.** Tremendous forces occur during the bending process which could cause serious injury.

General Working Stand Safety Warnings

WARNING: Read all safety warnings and all instructions provided with the working stand and the power tool to be mounted. Failure to follow the warnings and instructions may result in electric shock, fire and/or serious injury.

1. **Save all warnings and instructions for future reference.** The term "power tool" in the warnings refers to your mains-operated (corded) power tool or battery-operated (cordless) power tool.
2. **Disconnect the plug from the power source and/or the battery pack from the power tool before making any adjustments or changing accessories.** Accidental starting of the power tool is a cause of some accidents.
3. **Properly assemble the working stand before mounting the tool.** Proper assembly is important to prevent risk of collapse.
4. **Securely fasten the power tool to the working stand before use.** Power tool shifting on the working stand can cause loss of control.
5. **Place the working stand on a solid, flat and level surface.** When the working stand can shift or rock, the power tool or workpiece cannot be steadily and safely controlled.
6. **Do not overload the working stand or use as ladder or scaffolding.** Overloading or standing

on the working stand causes the stand to be "top-heavy" and likely to tip over.

SET UP

1. Open the Tripod and mount the machine to the Tripod by inserting the post of the Tripod into recess in the bottom of the machine.

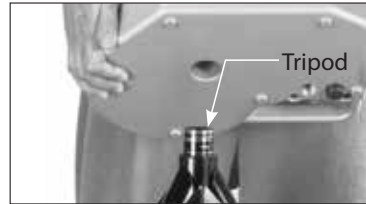

2. Mount a Bending Former suited to the pipe size onto the Output Spindle.
3. Mount the Bending Shoe and insert the Shoe Pivot Bolt into the appropriate hole in the Shoe Bracket to lock into place.

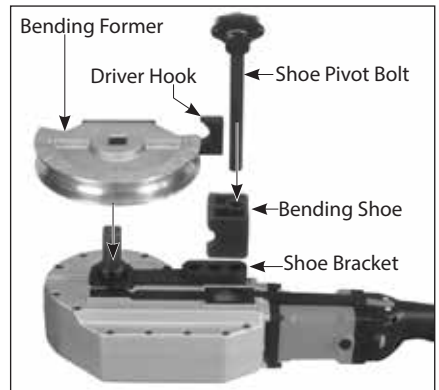

OPERATION

1. Ensure that the unit is in its starting position, if not please press and hold trigger until the Driver hook back to its (zero degree) starting position .

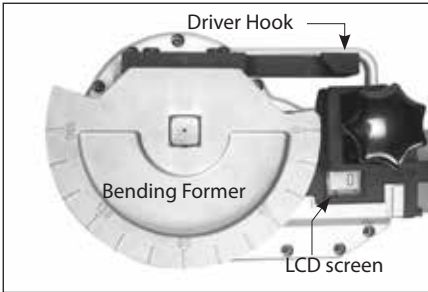

NOTE: Whenever the machine is first plugged in Press & hold the trigger of switch , it will automatically return to its (zero degree) starting position. in the other words the LCD screen shown (zero degree) The machine is now ready to perform the bending operation.

2. Insert the pipe into the Bending Former with at least 10mm of the end of the pipe projecting beyond the Driver Hook.

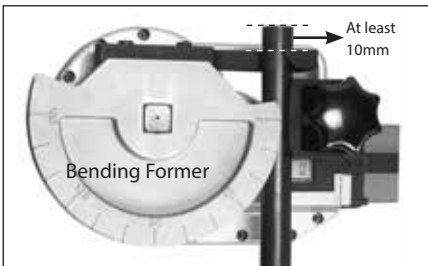

3. View the LCD screen and set to the desired angle by turning the Degree Selector Thumb Wheel.

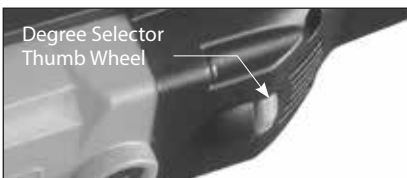

4. Set the Direction Lever to Forward by pushing the lever to the right "F" position.

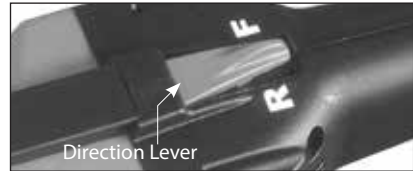

5. Press the Trigger Switch and hold until the pipe is bent to the desired angle. When the angle is reached, the machine will automatically stop.



6. To remove the pipe, set the Direction Lever to Reverse by pushing the lever to the left "R" position. Press the Trigger Switch. The machine will first back out about 15 degrees and stop. This is to allow the operator to remove the Shoe Pivot Bolt and Bending Shoe, which in turn allows the pipe to be removed.
7. Press the Trigger Switch for a second time and hold. The machine will return to its starting position.
8. The machine is now ready to perform the next bending operation.

Bending Calculations

It is important in bending to be able to calculate the position where you need to start the bend and the resulting length of the finished bend. It is also important to know how long the pipe needs to be at

the start. These can be calculated using the formulas and charts below.

Key:

A=The applied size: This is the starting point of the bend, measured from the end of the pipe (at the hook end of the former) to the zero degree position of the former with the machine returned to the rest position (before bending begins).

L=The total length of the pipe before it is bent

L₁=The resulting leg length on the end which is bent, measured from the centerline of the pipe. (See diagram)

L₂=The resulting leg length of the other end of the pipe which is not bent, measured from the centerline of the pipe. (See diagram)

L_R=The reserve length correction. (This is from the chart.) This is the correction factor which must be subtracted from the intended leg length (L1) in order to know where to begin the bend (A)

L_M=The minimum length correction. (This is from the chart.) This is the correction factor which must be added or subtracted from **L1** and **L2** to find how long the straight pipe needs to be at the beginning.

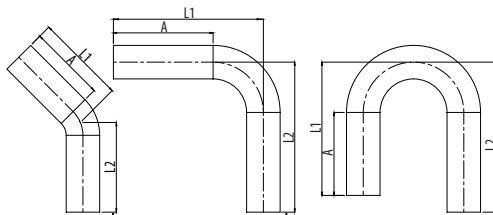

$L=L_1+L_2$
 $A=L_1-L_R$

$L=L_1+L_2-L_M$
 $A=L_1-L_R$

$L=L_1+L_2+L_M$
 $A=L_1-L_R$

Material Size	R(mm)	45°		90°		180°	
		L ₂ (mm)	L _R (mm)	L ₂ (mm)	L _R (mm)	L ₂ (mm)	L _R (mm)
5/8"(15.88mm)	64	25	-	66	35	66	52
3/4"(19.05mm)	77	30	-	79	35	79	63
7/8"(22.22mm)	88	35	-	92	48	92	96
1"(25.4mm)	102	39	-	103	58	103	112
1-8/16"(28.58mm)	115	45	-	118	55	118	118
1-4/16"(31.75mm)	127	50	-	130	71	130	135

Example: Finding the starting position to get the desired leg length at 90 degrees. If have a 1" pipe and we want to make a 90 degree bend in the pipe with a resulting leg length of 700mm, where would we position the pipe in the former?

Since $A=L_1-L_R$ we would take the desired leg length **L₁**, which is 700mm in this example, and subtract **L_R** from the chart for a 1" pipe at 90 degrees (It is also printed on the former), which is 103mm. $700-103=597$. Thus, for our starting position **A**, we would place the pipe at the 0 degree position on the former **597mm** from the end.

Example: Finding the required pipe length to get the desired two leg lengths at 90 degrees. If we needed the leg length of the remaining other side of the pipe in the example above to be 800mm, how long a pipe would we need?

For a 90 degree bend, $L=L_1+L_2-L_M$. The desired leg length **L₁** is 700mm, the other remaining leg length **L₂** is 800mm and the correction factor **L_M** from the chart for a 1" pipe at 90 degrees is 58mm. Thus $700+800-58=1442$ mm. We would need to start with a pipe which is 1442mm long.

Springback and Finding the Springback Correction Factor

Springback is a fact of life with pipe bending. In other words, when you bend a pipe to a certain angle, after the bending pressure releases, it will spring back somewhat to a slightly smaller angle. The only reliable way to compensate for springback is by trial and error. There are many factors which effect how much a particular workpiece will spring back; material type, wall thickness, etc. Steel tends to spring back more than copper and stainless tends to spring back more than steel. This machine has built in springback compensation, but it may need to be augmented with fine tuning of the preset bend angle. The digital preset system of this machine makes it extremely easy to consistently repeat results once the settings have been found from experience.

To find the spring back correction factor for a given size and type of pipe:

- First perform a trial bend in the pipe.
- Then measure the actual angle of the completed bend with an appropriate measuring tool.
- If it is slightly less than the desired angle, increase the digital preset, a small amount at a time, until the desired angle is achieved.

So, for example, a given pipe may need to be set at 91-95 or more degrees to achieve an actual 90 degree bend. Once the correction factor is found, it will usually be consistent for a given size and type of pipe.

MAINTENANCE

Every 50 hours of operation blow compressed air through the motor while running at no load to clean out accumulated dust. (If operating in especially dusty conditions, perform this operation more often.)

1. Keep the machine clean and free of dust.
2. Check for loose fittings and tighten as needed.
3. Ensure that the ventilation slots are clear so that motor can be cooled normally. Blow low pressure compressed air through the ventilation slots with the motor running to keep motor clean.

Cleaning the Check Ball

The check ball located on the electronics cover acts on a switch to send a signal to the electronics system.

With use, dust can accumulate in the check ball which will effect the function of the electronics. Periodically clean the check ball with compressed air to maintain normal functioning.

THE CARBON BRUSHES

The carbon brushes are a normal wearing part and must be replaced when they reach their wear limit.

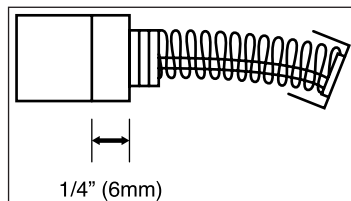

To replace:

simply remove the brush caps and withdraw the old brushes. Replace with new brushes (always replace as a pair) ensuring that they align properly and slide freely. Then replace the brush caps.



All machine repairs should be performed by a qualified repair technician.

Caution: If the LCD screen is damaged shown " E1 ", " E2 " & " E3" it must be replaced by the service organization.

Error Codes

E1: The machine has moved in the forward direction too long. Return to zero and restart. If problem persists, contact a service agent.

E2: The machine has moved in the reverse direction too long. Return to zero and restart. If problem persists, contact a service agent.

E3: The feedback sensor pickup has no signal. This is an internal electronics problem. Contact a service agent.

If the replacement of the power supply cord is necessary, this has to be done by the manufacturer or their agent in order to avoid a safety hazard.

WARNING: All repairs must be entrusted to an authorized service center. Incorrectly performed repairs could lead to injury or death.

WIRING

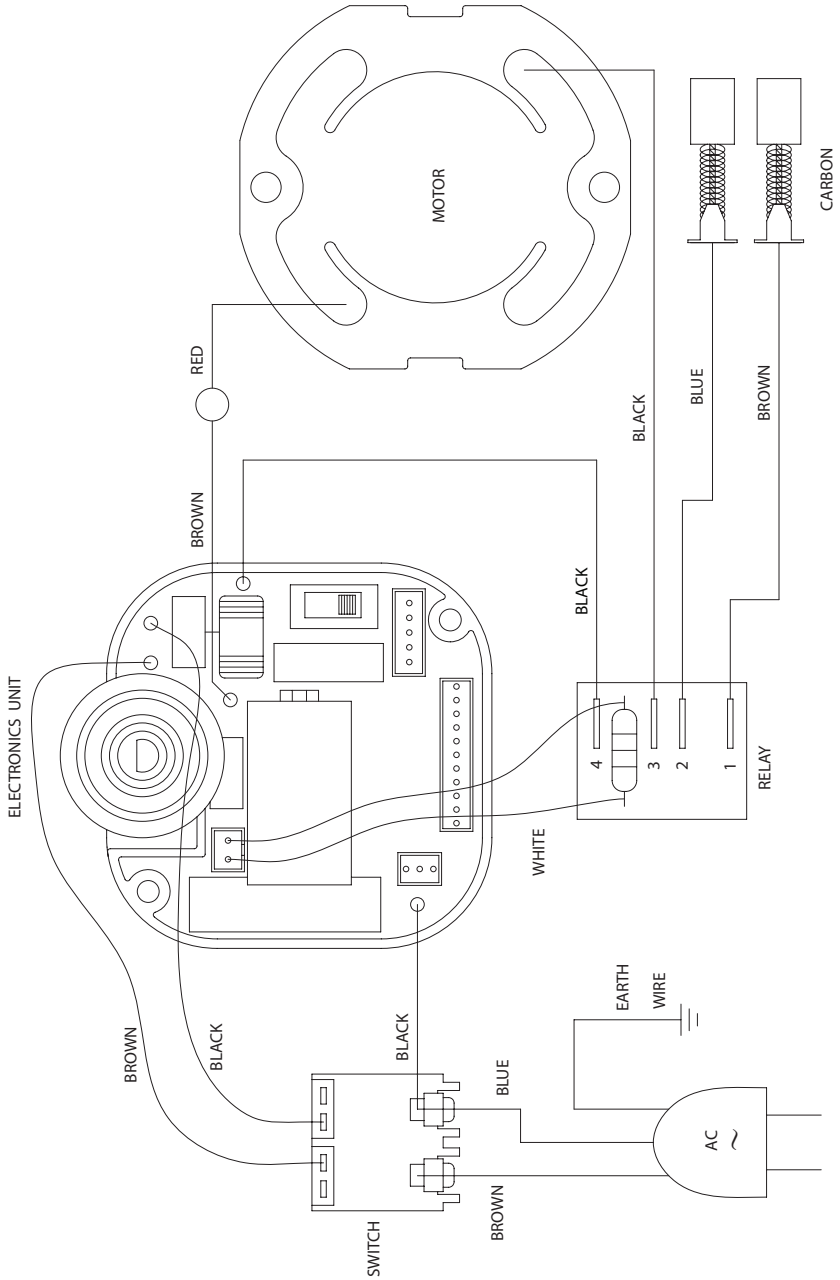

EXPLODED VIEW

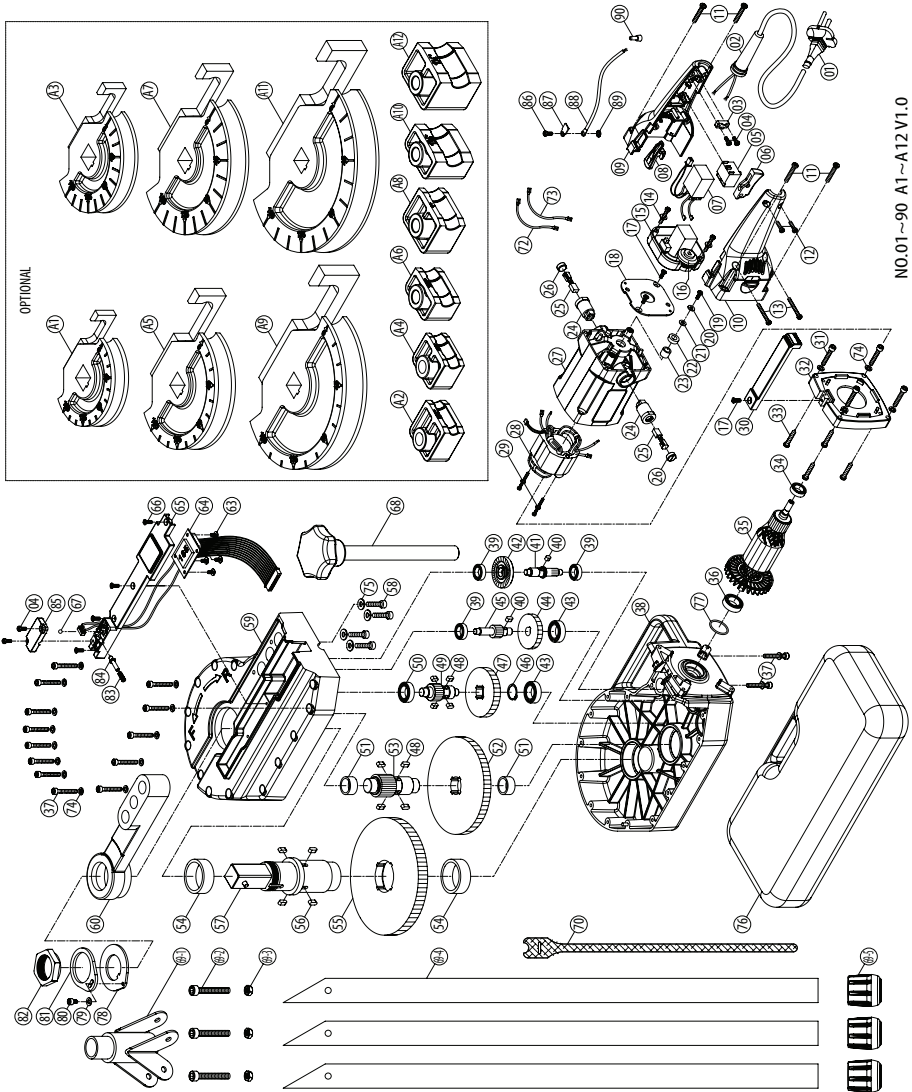

NO.01~90 A1~A12 V1.0

PARTS LIST

NO.	Parts Name	Q'TY	NO.	Parts Name	Q'TY
1	POWER SUPPLY CORD 1.0 x 2c x 3M VDE	1	54	BUSHING Ø40 x Ø48 x 16	2
2	CORD ARMOR	1	55	OUTPUT GEAR M2.5 x 64T	1
3	CORD CLIP	1	56	PARALLEL KEY 5 x 5 x 12	4
4	SCREW M4 x 14	2	57	OUTPUT SPINDLE	1
5	SWITCH	1	58	SCREW M6 x 30	4
6	TRIGGER	1	59	GEARCASE COVER	1
7	RELAY	1	60	SHOE BRACKET	1
8	COUNTER TRIGGER	1	61~62	N/A	-
9	HANDLE HALF-RIGHT	1	63	SCREW M4 x 8	4
10	HANDLE HALF-LEFT	1	64	LCD / CONTROL UNIT	1
11	SCREW M5 x 30	4	65	ELECTRONICS COVER	1
12	SCREW M4 x 16	2	66	FLAT HEAD SCREW M4 x 12	4
13	SCREW M4 x 25	2	67	CHECK BALL Ø5	1
14	SCREW M4 x 25	2	68	SHOE PIVOT BOLT	1
15	ELECTRONICS UNIT	1	69	TRIPOD BASE	1
16	SPEED CONTROL WHEEL	1	69-1	TRIPOD BASE	1
17	FLAT HEAD SCREW M4 x 10	3	69-2	SOCKET CAP SCREW M8 x 50	3
18	MOUNTING PLATE	1	69-3	NUT M8	3
19	SCREW M4 x 10	1	69-4	TRIPOD	3
20	FLAT WASHER Ø4 x Ø10 x 1	1	69-5	RUBBER END CAP	3
21	PLASTIC WASHER Ø4 x Ø11 x 1	1	70	TIE STRAP 38CM	1
22	PICKUP MAGNET Ø8 x Ø15 x 5	1	71	N/A	-
23	SPACER Ø8 x Ø12 x 14.5	1	72	WIRE LEAD	1
24	BRUSH HOLDER 7 x 11	2	73	WIRE LEAD	1
25	CARBON BRUSH 7 x 11	2	74	SPRING WASHER M5	17
26	BRUSH CAP 7 x 11	2	75	SPRING WASHER M6	4
27	MOTOR HOUSING	1	76	BLOW CASE	1
28	STATOR	1	77	O-RING Ø28 x 2	1
29	STATOR SCREW M5 x 60	2	78	SPACER PLATE	1
30	WIRING COVER	1	79	WASHER M5	1
31	SOCKET CAP SCREW M5 x 30	4	80	SCREW M5 x 8	1
32	FAN BAFFLE	1	81	ECCENTRIC PLATE	1
33	SCREW M5 x 25	4	82	NUT M36 x P1.5 x 13	1
34	BALL BEARING 608-2RU	1	83	SPRING Ø0.5 x Ø5 x Ø6 x 10T x 15L	1
35	ARMATURE M1.25 x 6T	1	84	SWITCH SHAFT	1
36	BALL BEARING 6001-LLU	1	85	MICROSWITCH COVER	1
37	SOCKET CAP SCREW M5 x 35	13	86	SCREW M4 x 8	1
38	GEARCASE	1	87	EARTHING MARKING	1
39	BALL BEARING 608 zz	3	88	EARTH WIRE 20# 35cm + 4R x 10	1
40	PARALLEL KEY 4 x 4 x 8	2	89	STAR WASHER M5	1
41	INPUT SHAFT M1.0 x 8T	1	90	END SPLICE CONNECTOR C4	1
42	INPUT GEAR M1.25 x 35T	1	A1	BENDING FORMER - 5/8" 5/8" R=4D	1
43	BALL BEARING 6200 zz	2	A2	BENDING SHOE - 5/8" 5/8"	1
44	SECOND REDUCTION GEAR M1.0 x 47T	1	A3	BENDING FORMER - 3/4" 3/4" R=4D	1
45	SECOND REDUCTION SHAFT M1.5 x 9T	1	A4	BENDING SHOE - 3/4" 3/4"	1
46	EXTERNAL CIRCLIP S-18	1	A5	BENDING FORMER - 7/8" 7/8" R=4D	1
47	THIRD REDUCTION GEAR M1.5 x 45T	1	A6	BENDING SHOE - 7/8" 7/8"	1
48	PARALLEL KEY 5 x 5 x 10	8	A7	BENDING FORMER - 1" 1" R=4D	1
49	THIRD REDUCTION SHAFT M2.0 x 10T	1	A8	BENDING SHOE - 1" 1"	1
50	BALL BEARING 6001 zz	1	A9	BENDING FORMER - 1-1/8" 1 1/8" R=4D	1
51	BUSHING Ø20 x Ø25 x 12	2	A10	BENDING SHOE - 1-1/8" 1 1/8"	1
52	FOURTH REDUCTION GEAR M2.0 x 67T	1	A11	BENDING FORMER - 1-1/4" 1 1/4" R=4D	1
53	FOURTH REDUCTION SHAFT M2.5 x 10T	1	A12	BENDING SHOE - 1-1/4" 1 1/4"	1

